

Sliding Door & Flush Fittings



Rectangular Pulls

SLIDING DOORS

Beautifully refined Rectangular Pulls are available in twelve standard sizes with a bespoke length option on request.



FIVE EXQUISITE DESIGNS



2500R
Plain

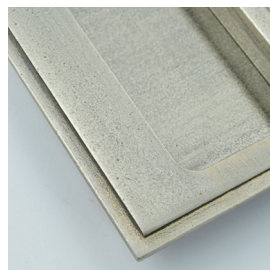

2510R
Edge Step

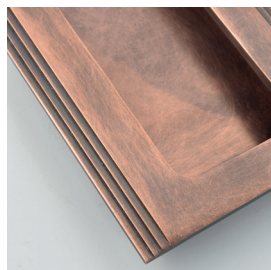

2520R
Straight Step

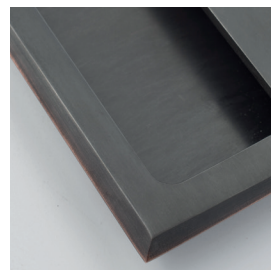

2530R
Pillow

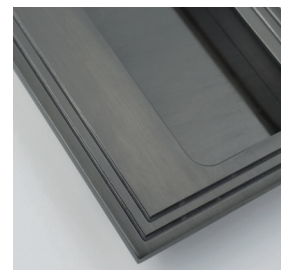

2540R
Reeded

How to Order

RECTANGULAR PULLS

Follow our seven simple steps to build your own product code.

1. Design 2520R	2. Function B	3. Size 305 x 64	4. Depth x9	5. Fixing AF	6. Lip OP	7. Finish PN
---------------------------	-------------------------	----------------------------	-----------------------	------------------------	---------------------	------------------------

1. Design

Choose from five rectangular designs.
(Add **2520R** for Straight Step)
2520R

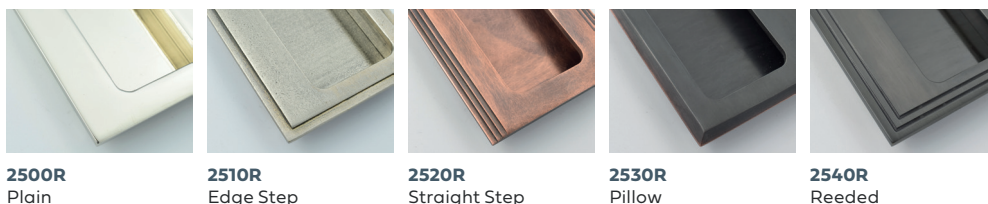

2. Function

Add the corresponding letter to choose your function.
(Add **B** for Bathroom Turn)
2520R-B

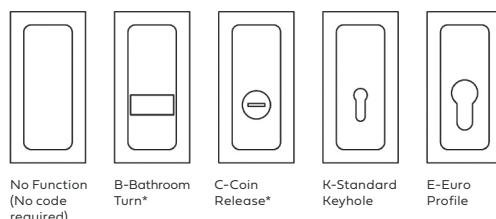

Functions are only recommended on 9mm and 11mm depths for ease of access. Bathroom function recommended on 64mm or 76mm widths. Add 2.5mm to the depth on the turn side, add 3mm depth on the release side.

Bathroom (Privacy) Turn also available in Diamond Orientation. Please suffix D to specify. E.g 2520R-BD).

*Bathroom Turn side and Coin Release side sold separately

3. Size

(Add 305 x 64 for 12" x 2 1/2" / 305 x 64mm)
2520R-B-305x64

Standard Size Chart	Widths		
	2" (51mm)	2 1/2" (64mm)	3" (76mm)
Lengths			
4" (102mm)	✓		
6" (152mm)	✓	✓	
8" (203mm)	✓	✓	✓
10" (254mm)	✓	✓	✓
12" (305mm)	✓	✓	✓

Bespoke length options available on request.
Please contact us with your enquiry.

4. Depth

(Add x9 x for 9mm depth)
2520R-B-305x64-x9

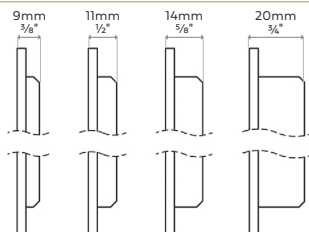

Single Lip and Double Lip: 14mm & 20mm only.

5. Fixing

(Add AF for Adhesive Fix)
2520R-B-305x64-x9-AF

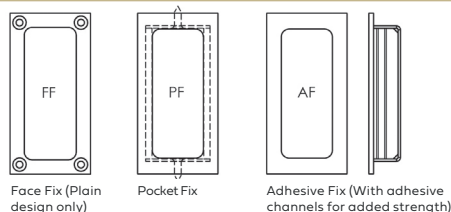

Face Fix: Plain designs only. Pocket Fix: 14mm & 20mm depths.

6. Lip

(Add OP for Open (No Lip))
2520R-B-305x64-x9-AF-OP

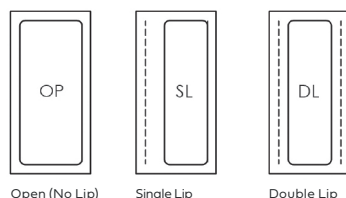

The Open option (no Lip) is available in all Pull sizes.

Single Lip and Double Lip is available in 14mm & 20mm depths only.

7. Finish

(Add PN for Polished Nickel)
2520R-B-305x64-x9-AF-OP-PN

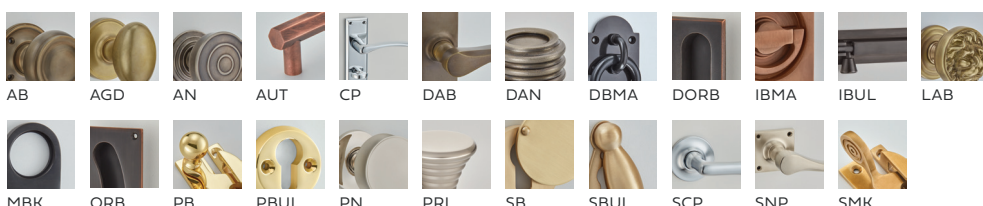

Square Pulls

SLIDING DOORS

Square pulls create an elegant and stylish appearance, harmonising with all styles of sliding doors.



FIVE EXQUISITE DESIGNS



2500SQ
Plain

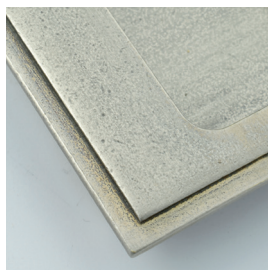

2510SQ
Edge Step

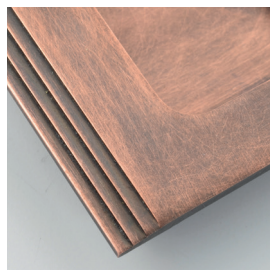

2520SQ
Straight Step

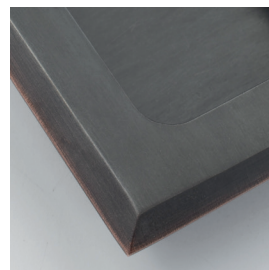

2530SQ
Pillow

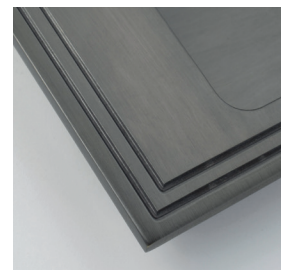

2540SQ
Reeded



How to Order

SQUARE PULLS

Follow our seven simple steps to build your own product code.

1. Design 2530SQ	2. Function C	3. Size 64 x 64	4. Depth x14	5. Fixing FF	6. Lip SL	7. Finish AB
----------------------------	-------------------------	---------------------------	------------------------	------------------------	---------------------	------------------------

1. Design

Choose from five square designs.
(Add **2530SQ** for Pillow)

2530SQ

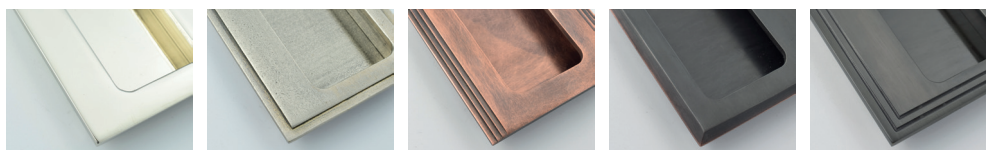

2500SQ
Plain

2510SQ
Edge Step

2520SQ
Straight Step

2530SQ
Pillow

2540SQ
Reeded

2. Function

Add the corresponding letter to choose your function.
(Add C for Coin Release)

2530SQ-C



No Function
(No code required)

B-Bathroom
Turn*

C-Coin
Release*

K-Standard
Keyhole

E-Euro
Profile

Bathroom (Privacy) Turn also available in Diamond Orientation. Please suffix D to specify. E.g 2520SQ-BD).

Functions are only recommended on 9mm and 11mm depths for ease of access. Bathroom function recommended on 64mm or 76mm widths. Add 2.5mm to the depth on the turn side, add 3mm depth on the release side. Bathroom (B), Coin (C) & Euro (E) not available on 2" Square Pull.

*Bathroom Turn side and Coin Release side sold separately

3. Size

(Add 64 x 64 for 2½" / 64mm)

2530SQ-C-64x64

2" (51mm) **2½"** (64mm) **3"** (76mm)

Turn and Release not available on 2" wide single Lip recess.

4. Depth

(Add x14 x for 14mm depth)

2530SQ-C-64x64-x14

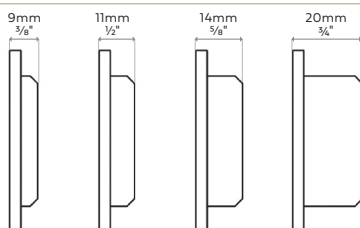

5. Fixing

(Add FF for Face Fix)

2530SQ-C-64x64-x14-FF

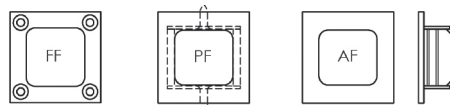

Face Fix
(Plain design only)

Pocket Fix

Adhesive Fix (With adhesive channels for added strength)

Single Lip and Double Lip: 14mm & 20mm only.

6. Lip

(Add SL for Single Lip)

2530SQ-C-64x64-x14-FF-SL

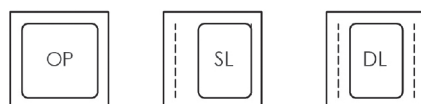

Open (No Lip)
45mm wide

Single Lip
33mm wide

Double Lip
33mm wide

The Open option (no Lip) is available in all Pull sizes.

Single Lip and Double Lip is available in 14mm & 20mm depths only.

7. Finish

(Add AB for Antique Brass)

2530SQ-C-64x64-x14-FF-SL-AB

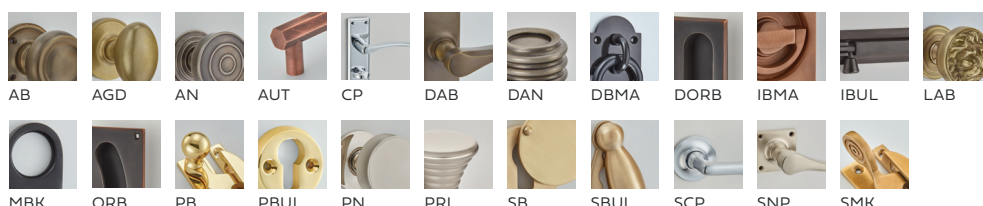

Round Pulls

SLIDING DOORS

Round Pulls provide flexibility and ease of installation and operation to make your project a real success.



FOUR EXQUISITE DESIGNS

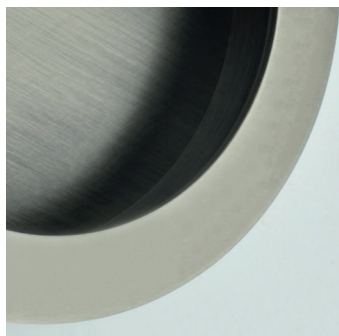

2500RD
Plain



2510RD
Edge Step



2530RD
Pillow

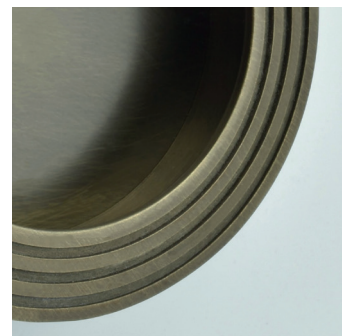

2540RD
Reeded

How to Order

ROUND PULLS

Follow our seven simple steps to build your own product code.

1. Design 2500RD	2. Function B	3. Size 76	4. Depth x9	5. Fixing AF	6. Finish PBUL
----------------------------	-------------------------	----------------------	-----------------------	------------------------	--------------------------

1. Design

Choose from five square designs.
(Add **2500RD** for Plain)

2500RD

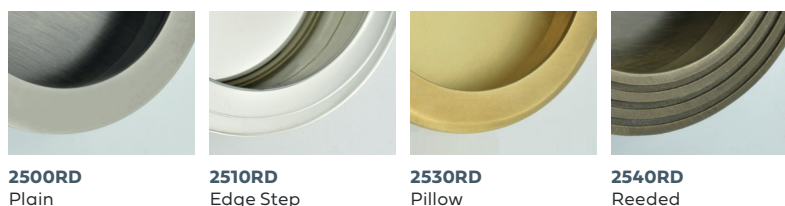

2500RD
Plain

2510RD
Edge Step

2530RD
Pillow

2540RD
Reeded

2. Function

Add the corresponding letter to choose your function.
(Add B for Bathroom Release)

2500RD-B

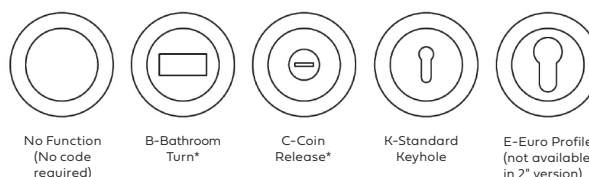

No Function
(No code required)

B-Bathroom
Turn*

C-Coin
Release*

K-Standard
Keyhole

E-Euro Profile
(not available
in 2" version)

Functions are only recommended on 9mm and 11mm depths for ease of access. Bathroom function recommended on 64mm or 76mm widths. Add 2.5mm to the depth on the turn side, add 3mm depth on the release side.

Bathroom (Privacy) Turn also available in Diamond Orientation. Please suffix D to specify. E.g 2520RD-BD).

*Bathroom Turn side and Coin Release side sold separately

3. Size

(Add 76 for 3" / 76mm)

2500RD-B-76

2" (51mm) **2½"** (64mm) **3"** (76mm)

4. Depth

(Add x9 x for 9mm depth)

2500RD-B-76-x9

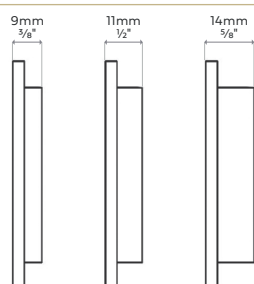

Maximum depth on Round Flush Pull 14mm.

5. Fixing

(Add AF for Adhesive Fix)

2500RD-B-76-x9-AF

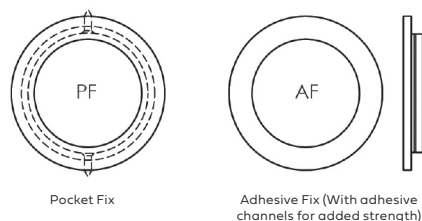

Pocket Fix

Adhesive Fix (With adhesive channels for added strength)

Due to limited protrusion, Face Fix is not available on Round Flush Pulls. Pocket Fix: 14mm only.

6. Finish

(Add PBUL for Polished Brass Unlacquered)

2500RD-B-76-x9-AF-PBUL

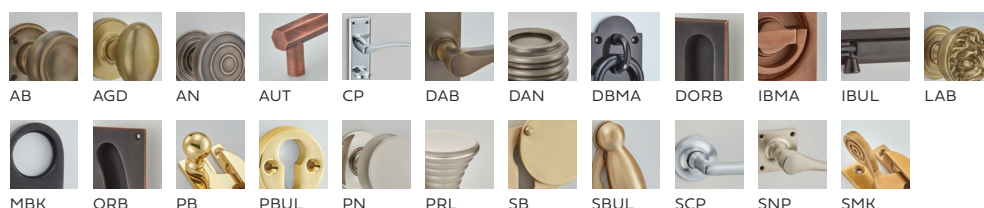

AB

AGD

AN

AUT

CP

DAB

DAN

DBMA

DORB

IBMA

IBUL

LAB

MBK

ORB

PB

PBUL

PN

PRL

SB

SBUL

SCP

SNP

SMK

Edge Pulls

SLIDING DOORS

A choice of three Edge Pulls to match your Croft sliding door hardware.

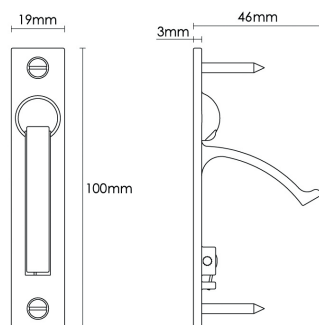
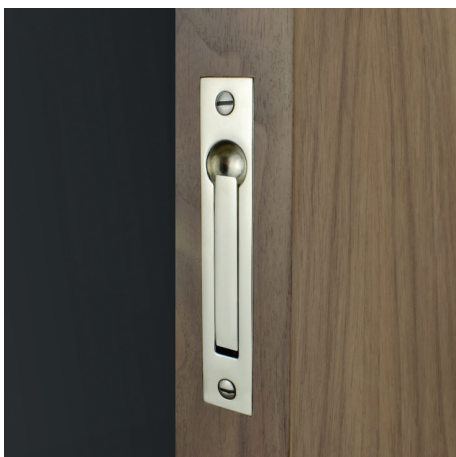

2600 Light Edge Pull

Slimline design, suitable for lighter sliding doors

Easy one-handed operation, with spring return mechanism

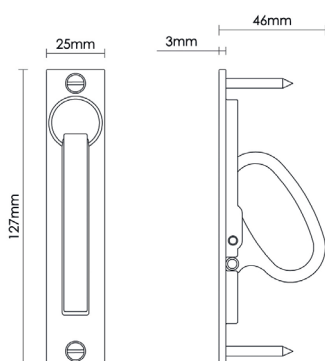

2601 Medium Edge Pull

A more robust sliding door Pull

Designed for smooth and effortless one-handed operation

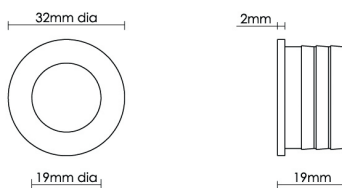

2603 Finger Edge Pull

A circular Pull with concentric lip to aid grip, creating a one-finger opening

Easy fitting, no screws required

Perfect accompaniment to our Round Pull design



Flush Rings, Latch and Lock Handles

FLUSH FITTINGS

Our Flush Fittings, suitable for various door types.



1804
Flush Lock Handle

- 146 x 70mm

Finish shown: Distressed Oil Rubbed Bronze

Also available:

1804L – Latch
1804E – Euro Profile
1804O – Oval Profile



2138
Flush Pull With Finger Recess

- 114 x 64mm

Finish shown: Tudor Bronze



2134
Plain Cast Flush Pull

Also available:

- 76 x 42mm (3")
- 102 x 51mm (4")

Finish shown: Imitation Bronze Metal Antique



2136
Kidney Cast Flush Pull

Also available:

- 76 x 42mm (3")
- 102 x 51mm (4")

Finish shown: Distressed Oil Rubbed Bronze

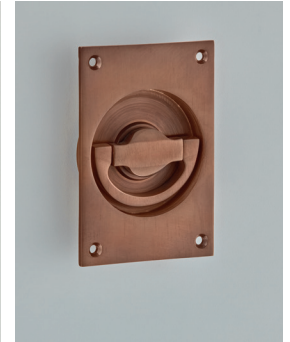

1804A
Flush Latch Handle

- 102 x 70mm

Finish shown: Imitation Bronze Metal Antique



2130
Bevelled Edge Flush Pull

- 76 x 42mm

Finish shown: Distressed Oil Rubbed Bronze



1804C
Circular Flush Latch Handle

- 68mm diameter

Finish shown: Imitation Bronze Metal Antique



1805
Flush Ring Handle

Available in the following sizes:

- 65 x 65mm
- 75 x 75mm
- 90 x 90mm

Finish shown: Tudor Bronze



1812
Squash Court Handle

- 89 x 89mm

Finish shown: Distressed Oil Rubbed Bronze

Also available:

1813 – Squash Court Handle Fixed



1050
Flush Ring

Available in the following sizes:

- 38 x 29mm (1 1/2 x 1 1/8")
- 50 x 38mm (2 x 1 1/2")
- 64 x 50mm (2 1/2 x 2")
- 77 x 57mm (3 x 2 1/4")

Finish shown: Distressed Antique Brass



CROFT

Manufacturers of the finest architectural hardware

Croft Architectural Hardware

Lower Lichfield Street, Willenhall, West Midlands, WV13 1QQ England

+44 (0)1902 606 493

sales@croft.co.uk

www.croft.co.uk